

Project:	Type:	QTY:
Product Code:		

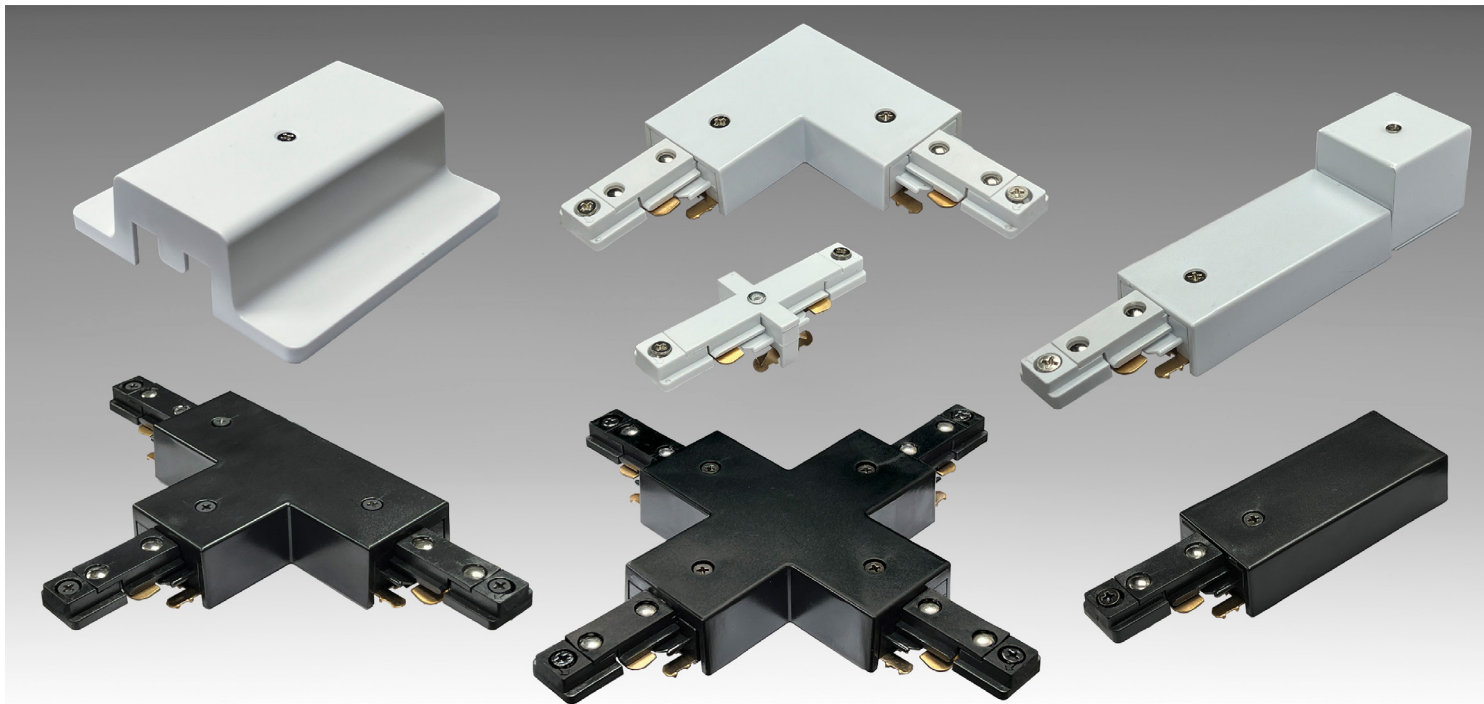

		Product Code	
		White	Black
Fittings	FLOATING canopy	JA001-W	JA001-B
	IN-LINE joiner	JA002-W	JA002-B
	L joiner	JA003-W	JA003-B
	T joiner	JA004-W	JA004-B
	X joiner	JA005-W	JA005-B
	TOP FEED connector	JA006TF-W	JA006TF-B
	DUAL FEED connector	JA006DF-W	JA006DF-B

Construction:

- Connector structures made with PVC materials
- Connector covers made with PMMA materials
- All current carrying materials are of copper
- 120V 20A rated

JA fittings

Dimensions:

Floating canopy

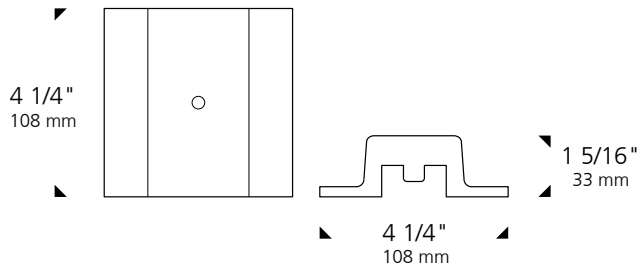

In-line joiner

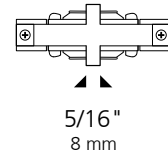

L joiner

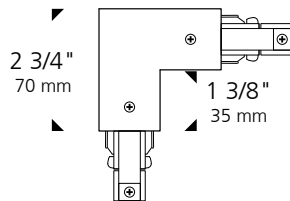

T joiner

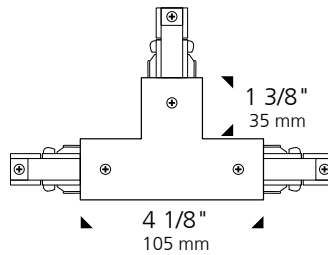

X joiner

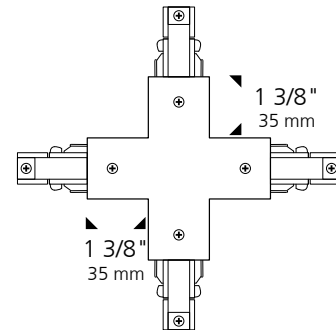

Top feed connector

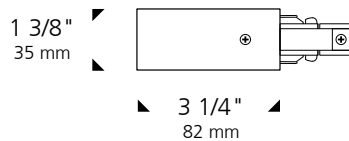

Dual feed connector

